

Shop » filtri emi emc » filtri scatolati



FILTRO 50A 600V AC TRIFASE SCATOLATO EMI

50A (UL-ENE)
Tensione 600/347V AC – 50/60Hz
Categoria Climatica: HPF 25/100/21
Massima corrente di fuga:
@480VAC 50/60Hz: 0.6mA
Hi-pot L-L: 2250VDC
Hi-pot L-N: 1300VDC
Hi-pot L-PE: 2750VDC

COD: **50S5-1AH1-T(56)**



DISEGNO

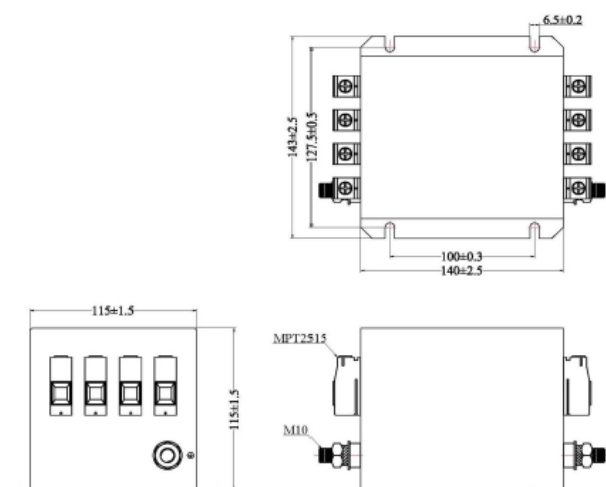

SPECIFICHE

Tensione	600/347V AC
Montaggio	morsettiera
Modello	3ph+N
Corrente Nominale	50A
N° di Stadi	1

CIRCUITO

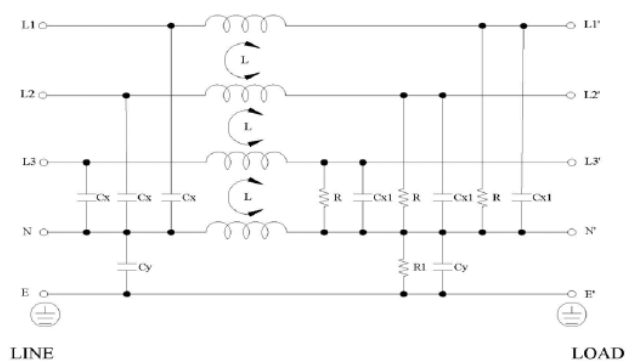

CURVA DI ATTENUAZIONE

